

PRODUCT SPECIFICATION

Model No.: FYL-3019EGW1A-CC

Descriptions:
<ul style="list-style-type: none"> ■ Dice material: GaAsP; AlGaInP. ■ Emitting Color: Orange, Yellow Green. ■ Device Outline: Φ3mm round type. ■ Lens Type: White Diffused.

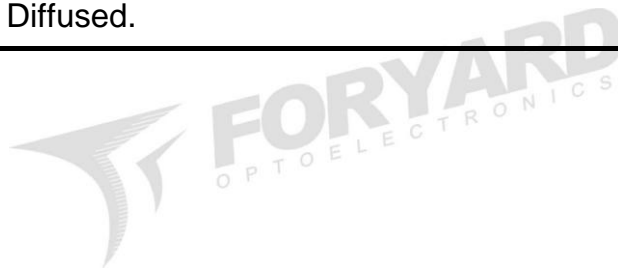

CUSTOMER APPROVED SIGNATURES	APPROVED BY	CHECKED BY	PREPARED BY

NINGBO FORYARD OPTOELECTRONICS CO.,LTD.

Add:No. 666 Jinghua Road, Hi-tech Park, Ningbo, Zhejiang, China

Zip:315103

Tel: 0086-574-87933652 87922206 87927870

Fax: 0086-574-87927917

E-mail:Sales@foryard.com (General)

Model No.: FYL-3019EGW1A-CC

■ Features

- 1.Low power consumption.
- 2.High efficiency.
- 3.General purpose leads.
- 4.High intensity.
- 5.RoHs compliant.

■ Package configuration

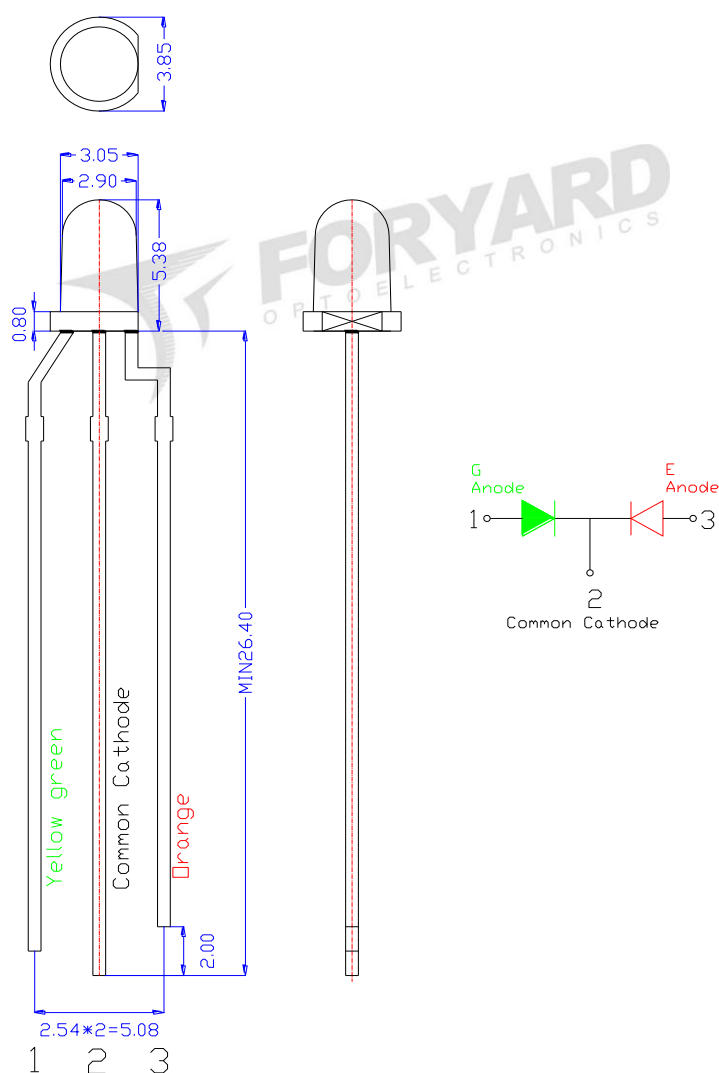

Notes:

1. All dimensions are millimeters (inches)
2. Tolerance is $\pm 0.25\text{mm}$ (.010") unless otherwise noted.
3. The specifications, characteristics and technical data described in the datasheet are subject to change without prior notice.
4. The drawing is different from the actual one, please refer to the sample.

Model No.: FYL-3019EGW1A-CC

■ Absolute Maximum Ratings(Ta=25°C)

Parameter	MAX.		Unit
	E	G	
Power Dissipation	80	75	mW
Peak Forward Current (1/10 Duty Cycle, 0.1ms Pulse Width)	150	100	mA
Continuous Forward Current	30	30	mA
Derating Linear From 50°C	0.4		mA/°C
Reverse Voltage	5		V
Operating Temperature Range	-40°C to +85°C		
Storage Temperature Range	-40°C to +100°C		
Lead Soldering Temperature[4mm(.157") From Body]	260°C for 5 Seconds		

■ Typical Electrical & Optical Characteristics(Ta=25°C)

Parameter	Symbol	Colour	Min.	Typ.	Max.	Unit	Test Condition
Luminous Intensity	I_v	E	9	20	45	mcd	IF=20mA
		G	20	45	100		
Viewing Angle	$2\theta_{1/2}$	E	---	50	---	Deg	
		G	---	50	--		
Peak Emission Wavelength	λ_p	E	---	625	--	nm	
		G	---	570	--		
Dominant Wavelength	λ_d	E	618	622	627	nm	
		G	568	572	574		
Spectral Line Half-Width	$\Delta\lambda$	E	---	35	--	nm	
		G	---	10	--		
Forward Voltage	V_F	E	1.8	2.1	2.4	V	
		G	1.8	2.1	2.6		
Reverse Current	I_R		---	---	10	μA	VR=5V

Note:

- 1.Luminous Intensity is based on the Foryard standards.
- 2.Pay attention about static for InGaN

Model No.: FYL-3019EGW1A-CC

Typical Eletrical/Optical Characteristics Curves(Ta=25°C Unless Otherwise Noted)

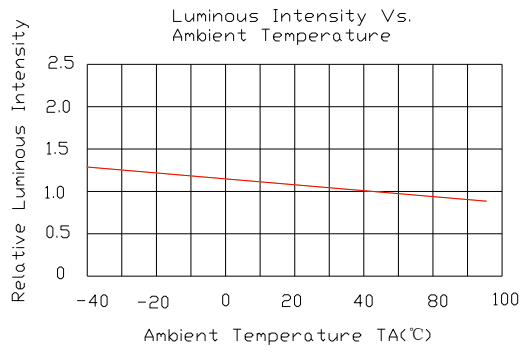
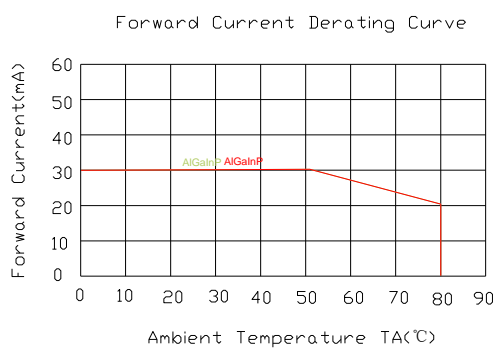
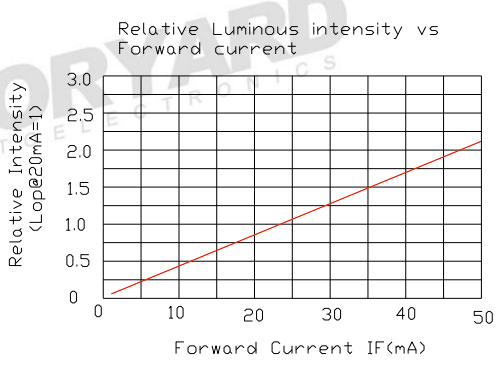
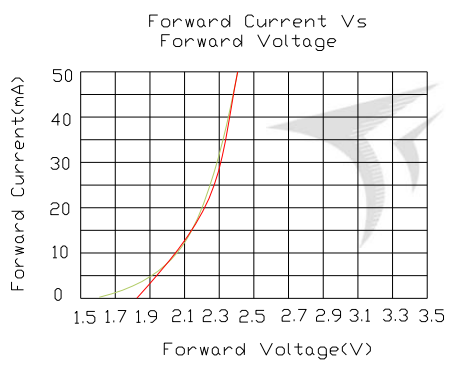
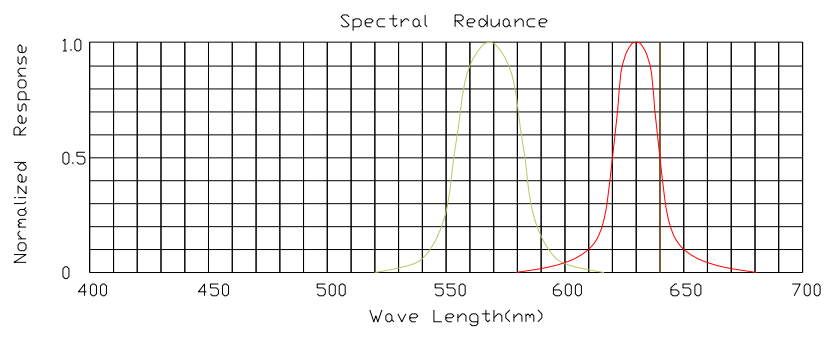

Radiation pattern

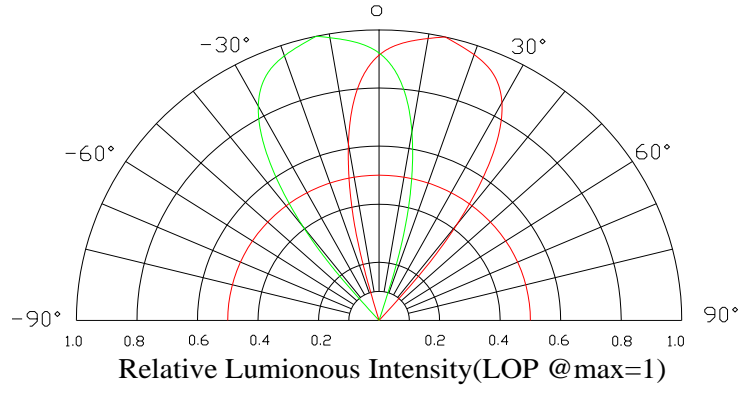

Model No.: FYL-3019EGW1A-CC

LAMP PACKING.

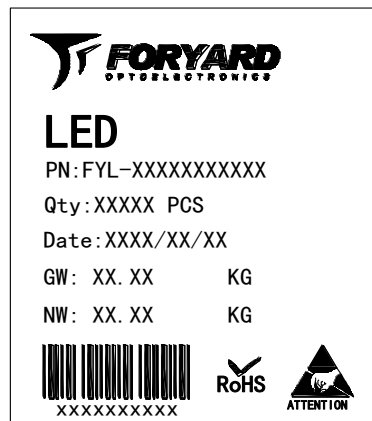
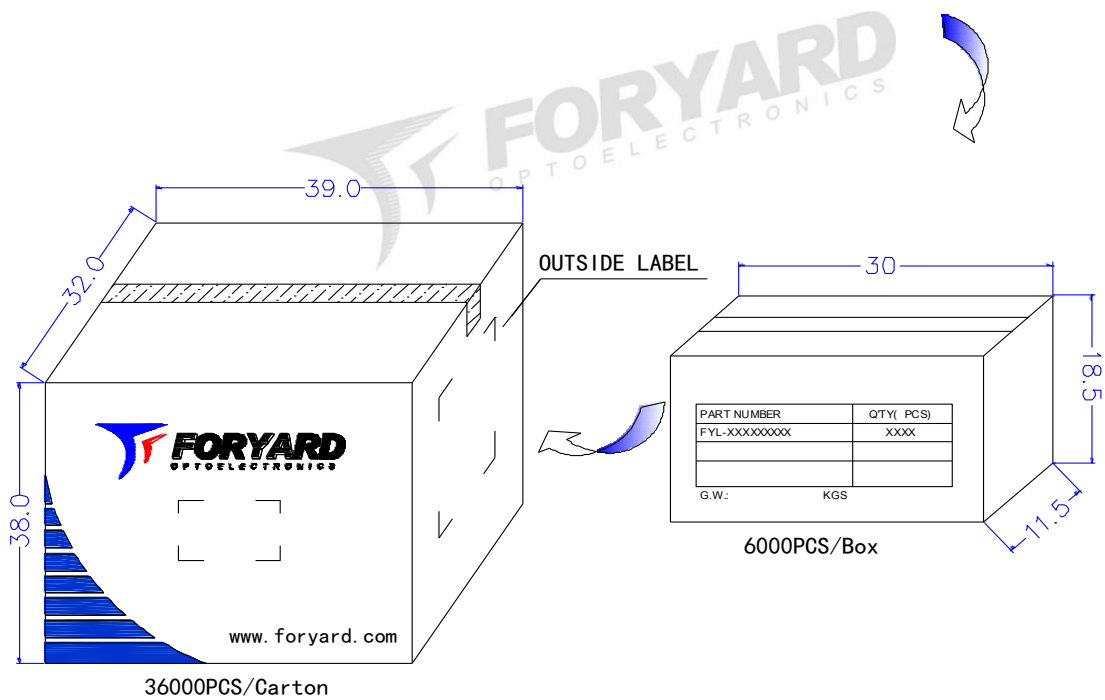
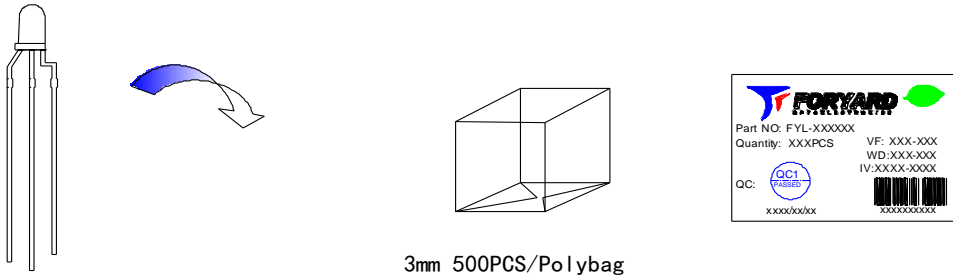

OUTSIDE LABEL

Note: The specifications are subject to change without notice. Please contact us for updated information.