

PRODUCT SPECIFICATION

Model No.: FYL-5013HD1C

Descriptions:
<ul style="list-style-type: none"> ■ Dice material: GaP. ■ Emitting Color: Red. ■ Device Outline: Φ5mm round type. ■ Lens Type: Red Diffused.



CUSTOMER APPROVED SIGNATURES	APPROVED BY	CHECKED BY	PREPARED BY

NINGBO FORYARD OPTOELECTRONICS CO.,LTD.

Add:No. 666 Jinghua Road, Hi-tech Park, Ningbo, Zhejiang, China

Zip:315103

Tel: 0086-574-87933652 87922206 87927870

Fax: 0086-574-87927917

E-mail:Sales@foryard.com (General)

Model No.: FYL-5013HD1C

■ Features

- 1.Low power consumption.
- 2.High efficiency.
- 3.General purpose leads.
- 4.High intensity.
- 5.RoHs compliant.

■ Package configuration

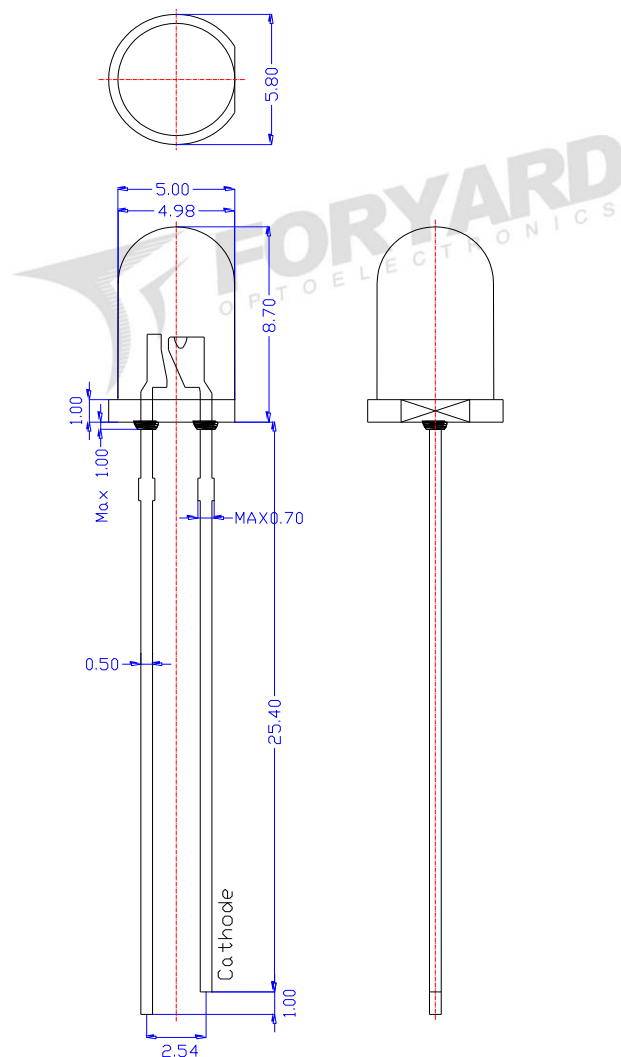

Notes:

1. All dimensions are millimeters (inches)
2. Tolerance is $\pm 0.25\text{mm}$ (.010") unless otherwise noted.
3. The specifications, characteristics and technical data described in the datasheet are subject to change without prior notice.
4. The drawing is different from the actual one, please refer to the sample.

Model No.: FYL-5013HD1C

■ Absolute Maximum Ratings(Ta=25°C)

Parameter	MAX.	Unit
Power Dissipation	40	mW
Peak Forward Current (1/10 Duty Cycle, 0.1ms Pulse Width)	50	mA
Continuous Forward Current	15	mA
Derating Linear From 50°C	0.4	mA/°C
Reverse Voltage	5	V
Operating Temperature Range	-40°C to +85°C	
Storage Temperature Range	-40°C to +100°C	
Lead Soldering Temperature[4mm(.157") From Body]	260°C for 5 Seconds	

■ Typical Electrical & Optical Characteristics(Ta=25°C)

Parameter	Symbol	Min.	Typ.	Max.	Unit	Test Condition
Luminous Intensity	I_v	2	5	8	mcd	IF=20mA
Viewing Angle	$2\theta_{1/2}$	---	20	---	Deg	
Peak Emission Wavelength	λ_p	---	700	--	nm	
Dominant Wavelength	λ_d	---	660	---	nm	
Spectral Line Half-Width	$\Delta\lambda$	---	90	--	nm	
Forward Voltage	V_F	1.8	2.1	2.4	V	VR=5V
Reverse Current	I_R	---	---	10	μA	

Note:

- 1.Luminous Intensity is based on the Foryard standards.
- 2.Pay attention about static for InGaN

Model No.: FYL-5013HD1C

■ Typical Eletrical/Optical Characteristics Curves(Ta=25°C Unless Otherwise Noted)

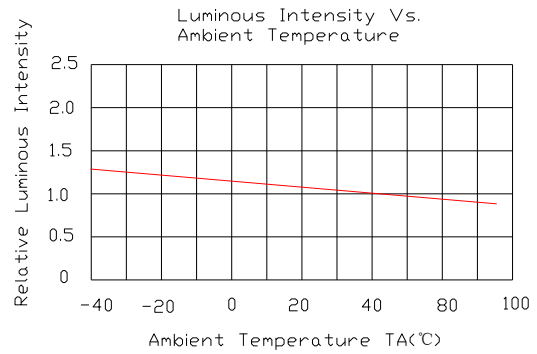
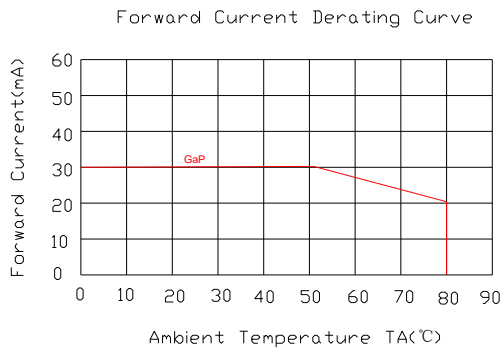
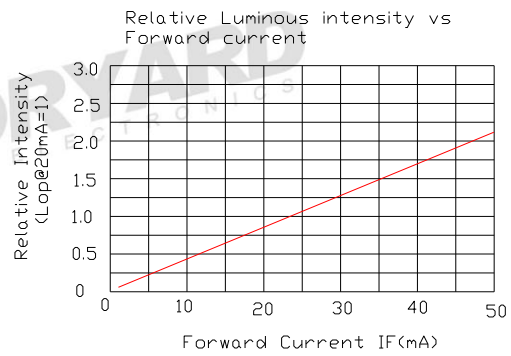
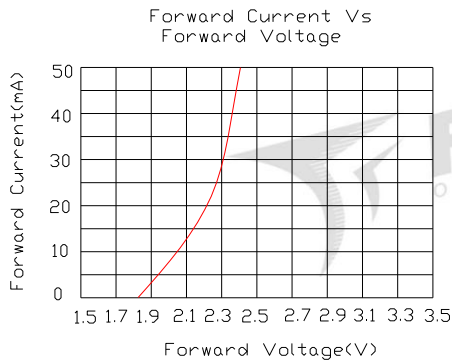
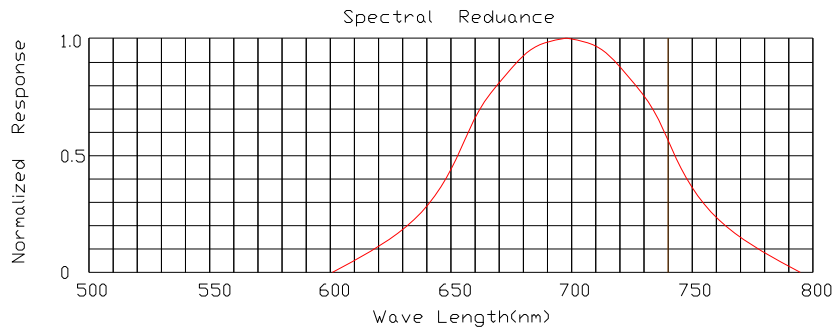

■ Radiation pattern

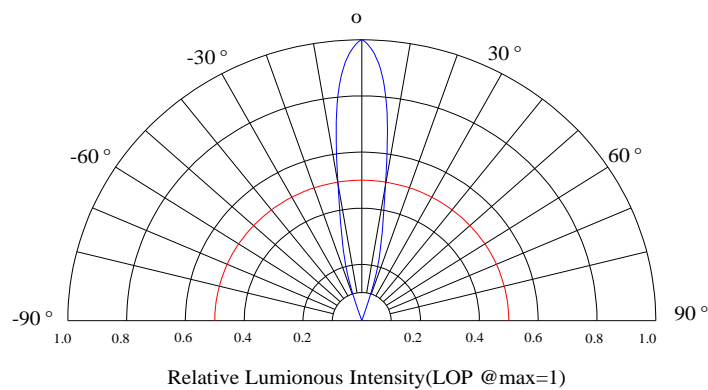

Model No.	FYL-5013HD1C
Date / Rev.	2020.04.18 / A

Model No.: FYL-5013HD1C

■ LAMP PACKING.

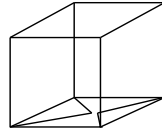
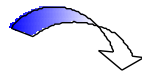
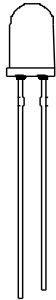

5mm 1000PCS/Polybag

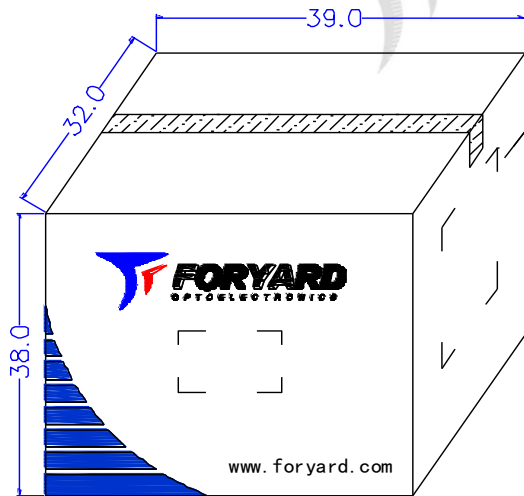

48000PCS/Carton

OUTSIDE LABEL

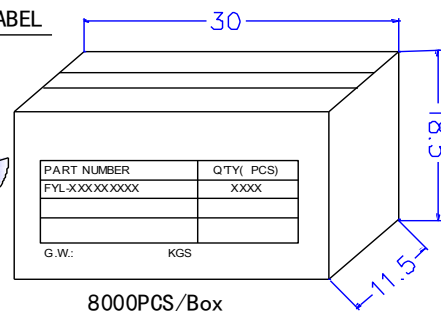

8000PCS/Box

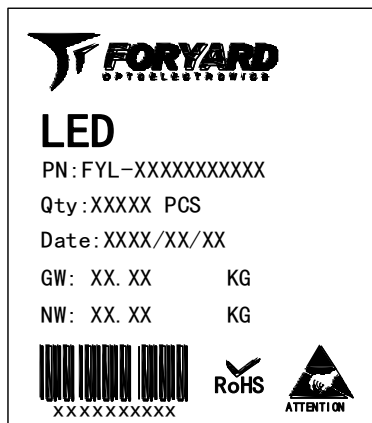

OUTSIDE LABEL

Note: The specifications are subject to change without notice. Please contact us for updated information.