

PRODUCT SPECIFICATION

Model No.: FYL-5013SUGC1C

Descriptions:
<ul style="list-style-type: none"> ■ Dice material: AlGaInP. ■ Emitting Color: Super Bright Yellow Green. ■ Device Outline: Φ5mm round type. ■ Lens Type: Water clear.



CUSTOMER APPROVED SIGNATURES	APPROVED BY	CHECKED BY	PREPARED BY

NINGBO FORYARD OPTOELECTRONICS CO.,LTD.

Add:No. 666 Jinghua Road, Hi-tech Park, Ningbo, Zhejiang, China

Zip:315103

Tel: 0086-574-87933652 87922206 87927870

Fax: 0086-574-87927917

E-mail:Sales@foryard.com (General)

Model No.: FYL-5013SUGC1C

■ Features

- 1.Low power consumption.
- 2.High efficiency.
- 3.General purpose leads.
- 4.High intensity.
- 5.RoHs compliant.

■ Package configuration

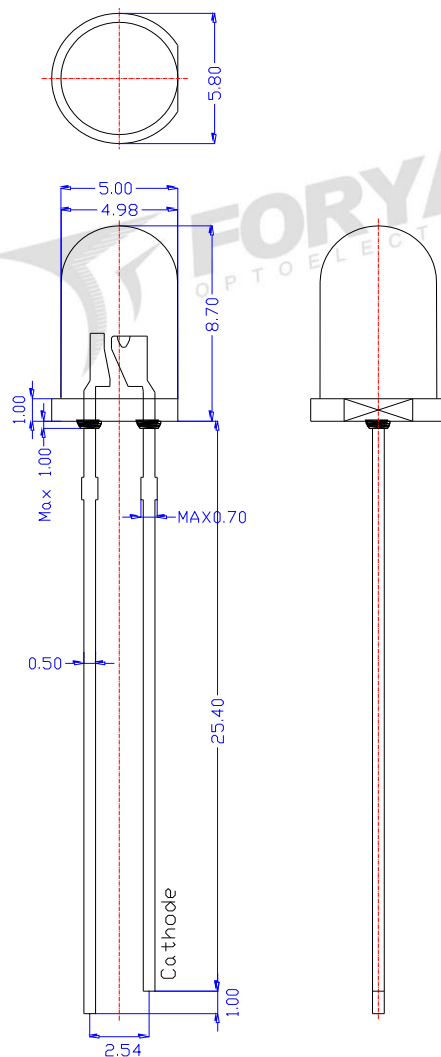

Notes:

1. All dimensions are millimeters (inches)
2. Tolerance is $\pm 0.25\text{mm}$ (.010") unless otherwise noted.
3. The specifications, characteristics and technical data described in the datasheet are subject to change without prior notice.
4. The drawing is different from the actual one, please refer to the sample.

Model No.: FYL-5013SUGC1C

■ Absolute Maximum Ratings(Ta=25°C)

Parameter	MAX.	Unit
Power Dissipation	75	mW
Peak Forward Current (1/10 Duty Cycle, 0.1ms Pulse Width)	100	mA
Continuous Forward Current	30	mA
Derating Linear From 50°C	0.4	mA/°C
Reverse Voltage	5	V
Operating Temperature Range	-40°C to +85°C	
Storage Temperature Range	-40°C to +100°C	
Lead Soldering Temperature[4mm(.157") From Body]	260°C for 5 Seconds	

■ Typical Electrical & Optical Characteristics(Ta=25°C)

Parameter	Symbol	Min.	Typ.	Max.	Unit	Test Condition
Luminous Intensity	I_V	1800	3000	4750	mcd	IF=20mA
Viewing Angle	$2\theta_{1/2}$	---	10	---	Deg	
Peak Emission Wavelength	λ_p	---	570	--	nm	
Dominant Wavelength	λ_d	568	572	576	nm	
Spectral Line Half-Width	$\Delta\lambda$	---	30	--	nm	
Forward Voltage	V_F	1.8	2.1	2.4	V	VR=5V
Reverse Current	I_R	---	---	10	μ A	

Note:

- 1.Luminous Intensity is based on the Foryard standards.
- 2.Pay attention about static for InGaN

■ Luminous Intensity Guide (Unit: mcd) @IF=20mA

Code	N18	N19	N20	N21
Luminous Intensity(mcd)	1800~2300	2300~3000	3000~3800	3800~4750

Tolerance of measurement of luminous intensity is $\pm 15\%$

■ Dominate Wavelength Guide (Unit: nm) @IF=20mA

Code	YG4	YG5	YG6	YG7
Dominate Wavelength(nm)	568~570	570~572	572~574	574~576

Tolerance for each Dominate Wavelength bin is $\pm 1\text{nm}$

■ Forward Voltage Guide (Unit: V) @IF=20mA

Code	V2	V3a	V3b	V4
Forward Voltage(V)	1.8~2.0	2.0~2.1	2.1~2.2	2.2~2.4

Tolerance of measurement of forward voltage is $\pm 0.1\text{V}$

Model No.: FYL-5013SUGC1C

■ Typical Eletrical/Optical Characteristics Curves(Ta=25°C Unless Otherwise Noted)

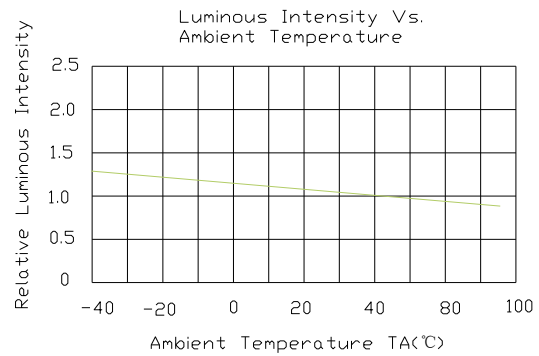
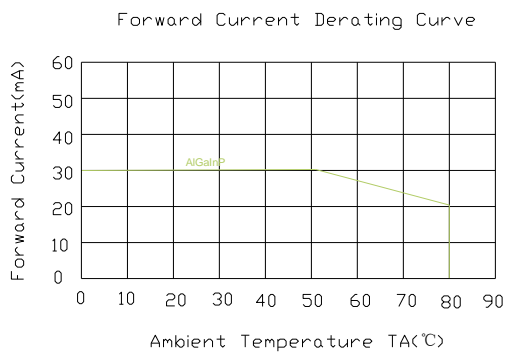
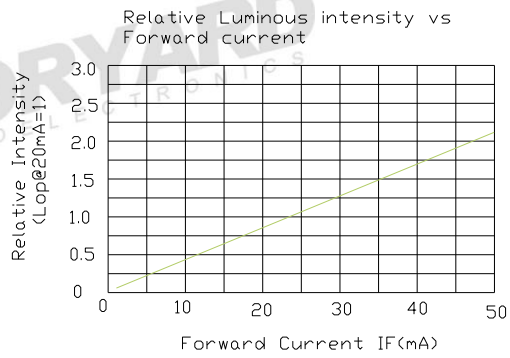
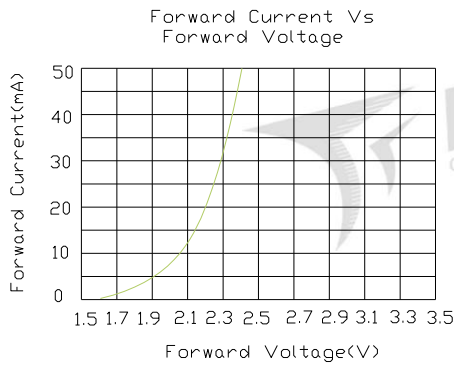
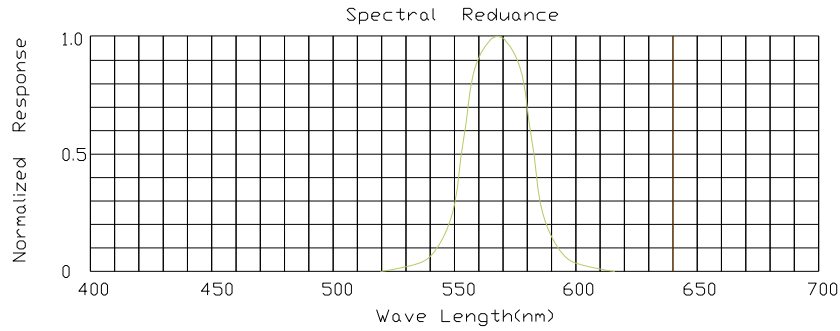

■ Radiation pattern

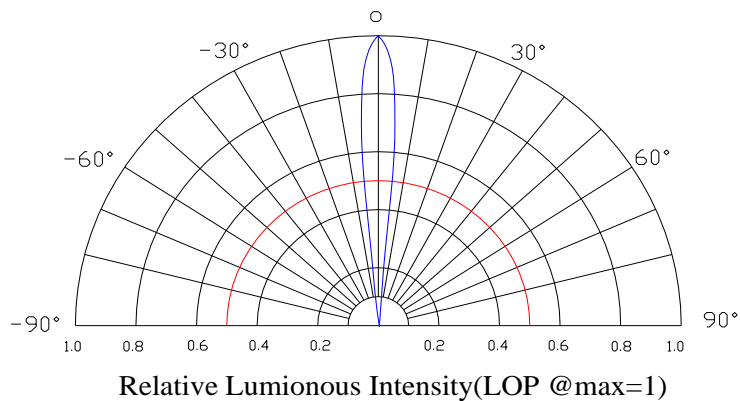

Model No.: FYL-5013SUGC1C

■ LAMP PACKING.

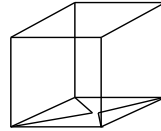
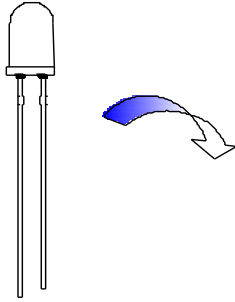

5mm 1000PCS/Polybag

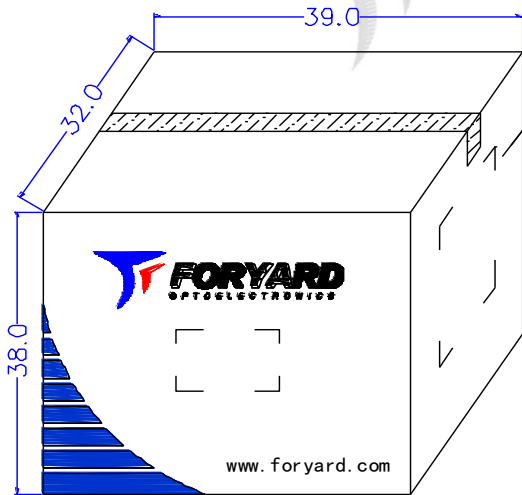

48000PCS/Carton

OUTSIDE LABEL

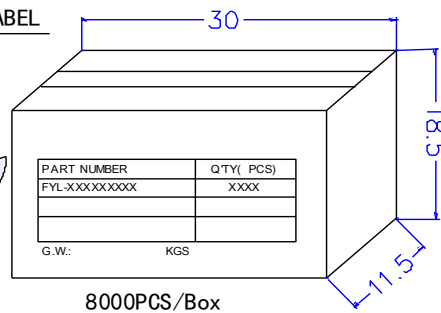

8000PCS/Box

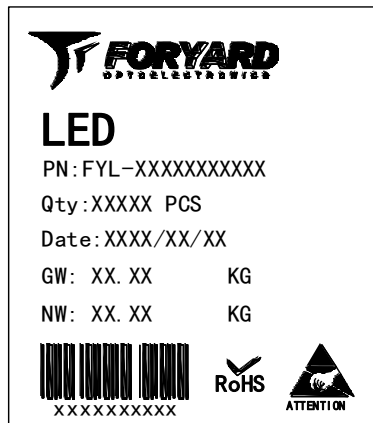

OUTSIDE LABEL

Note: The specifications are subject to change without notice. Please contact us for updated information.