

SECTION B-B  
SCALE 2 : 3

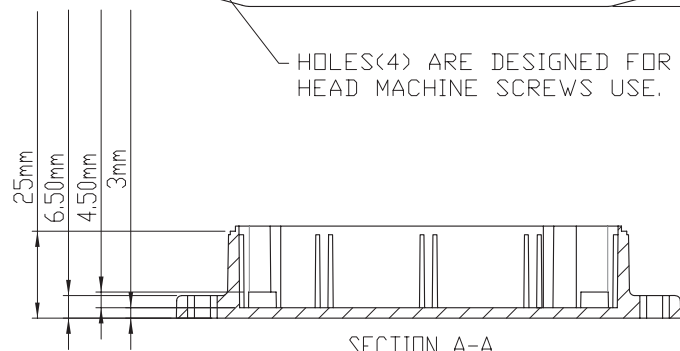

SECTION A-A  
SCALE 2 : 3

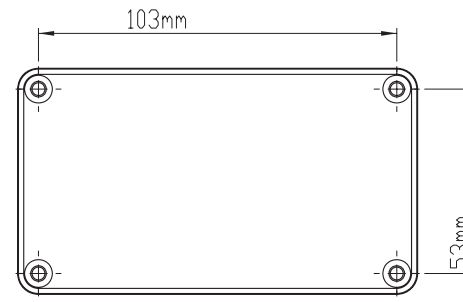
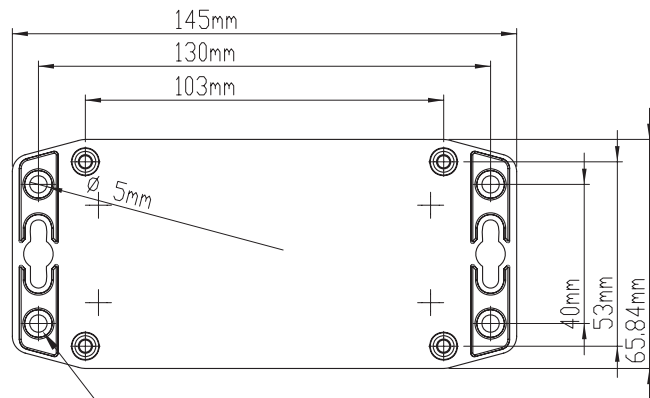
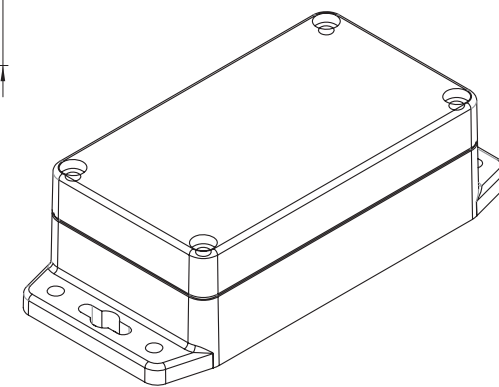
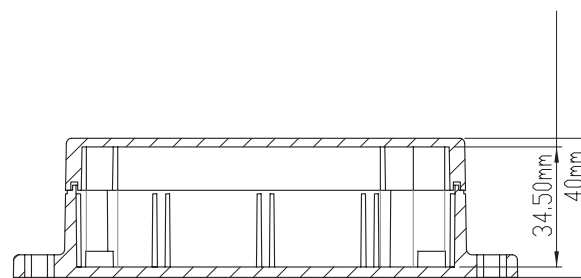

TOLERANCES: +/- 0.30 mm (+/- 0.012in)

宣又實業有限公司  
GAINTA INDUSTRIES LTD.

繪圖 DRA'D BY  
JACKY

日期 DATE  
2010/11/8

材質 MATE.  
PC ; ABS

圖名TITLE:  
G203MF ; G304MF

圖號DWG NO:

版次REVISID:  
A