

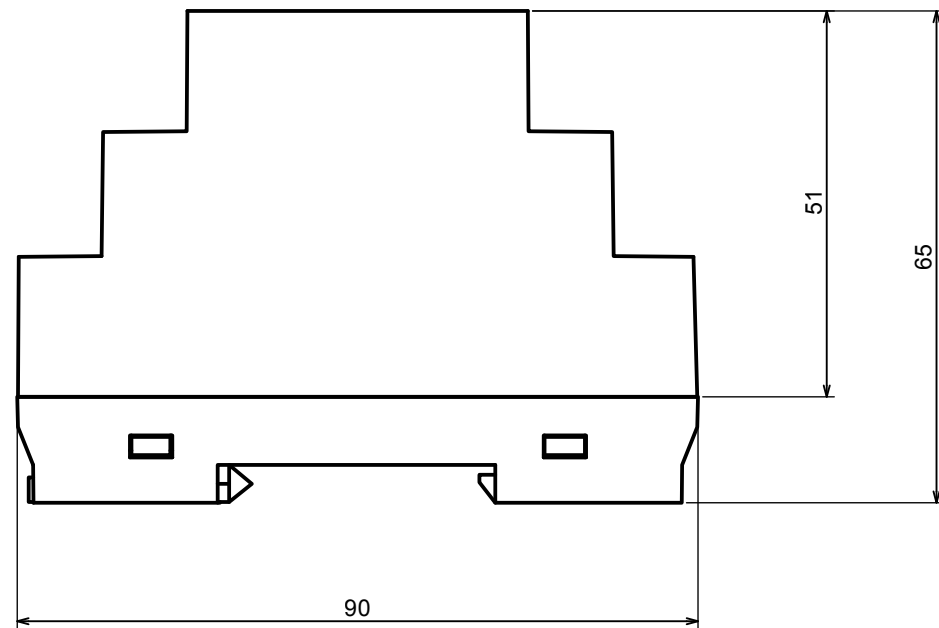

A |

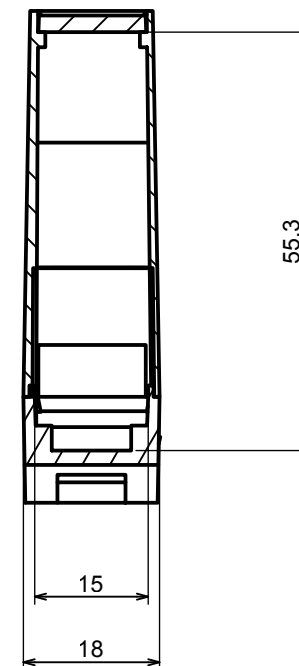

A |

A-A



All rights reserved, Copyright Kradox 2017		
Product model	Enclosure Z105 - Assembly	
Format: A3	Material: PS, ABS	
Scale 1:1	Tolerance: +/- 0.8	

A |

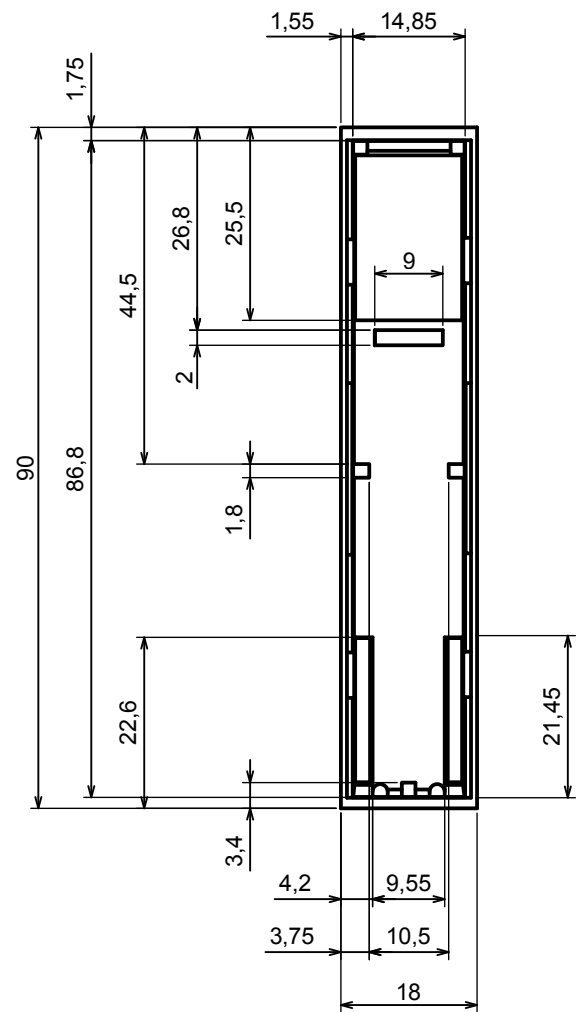

A-A

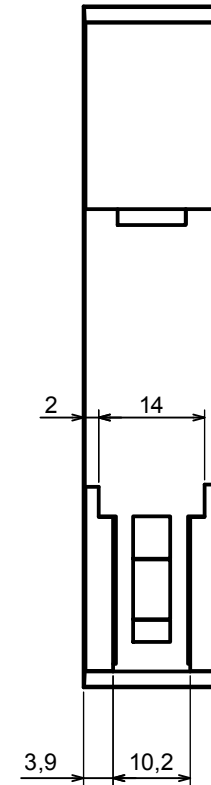
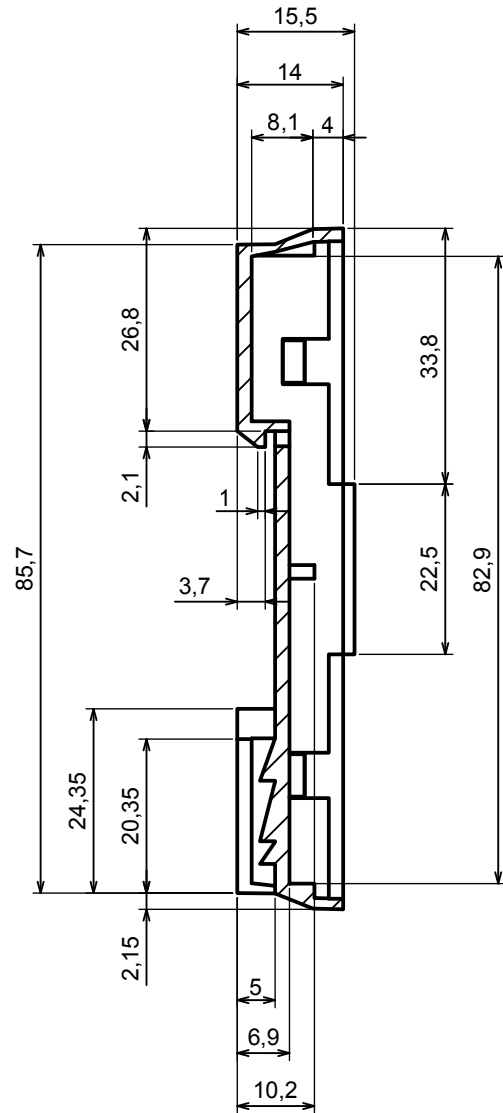

A |

All rights reserved, Copyright Kradox 2017		
Product model	Enclosure Z105 - Base	
Format: A3	Material: PS, ABS	
Scale 1:1	Tolerance: +/- 0.8	

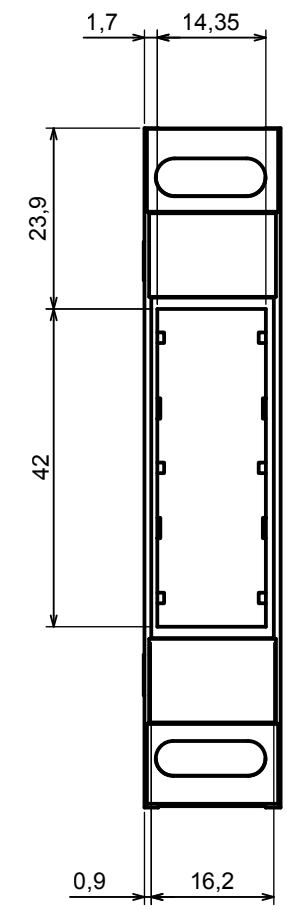
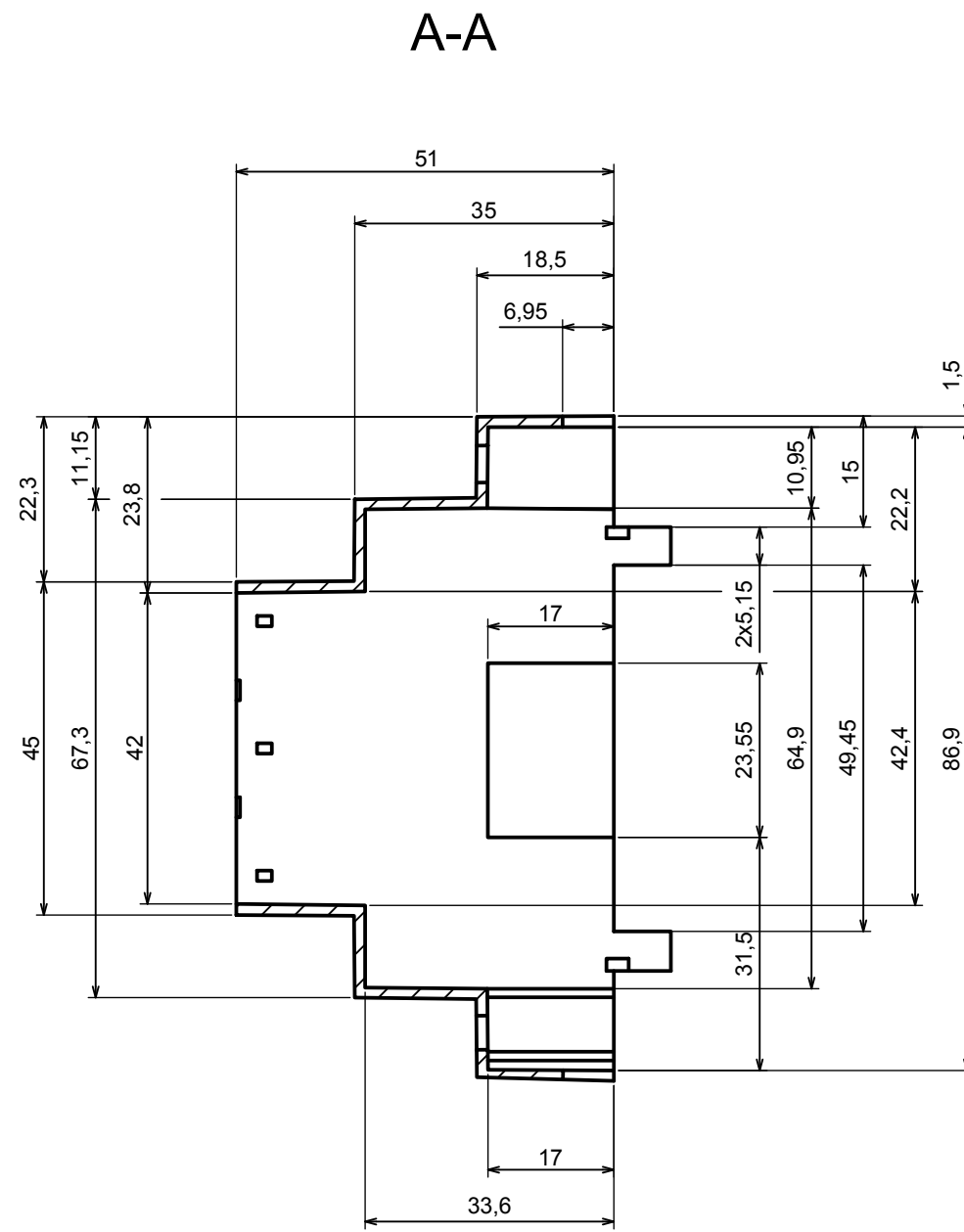
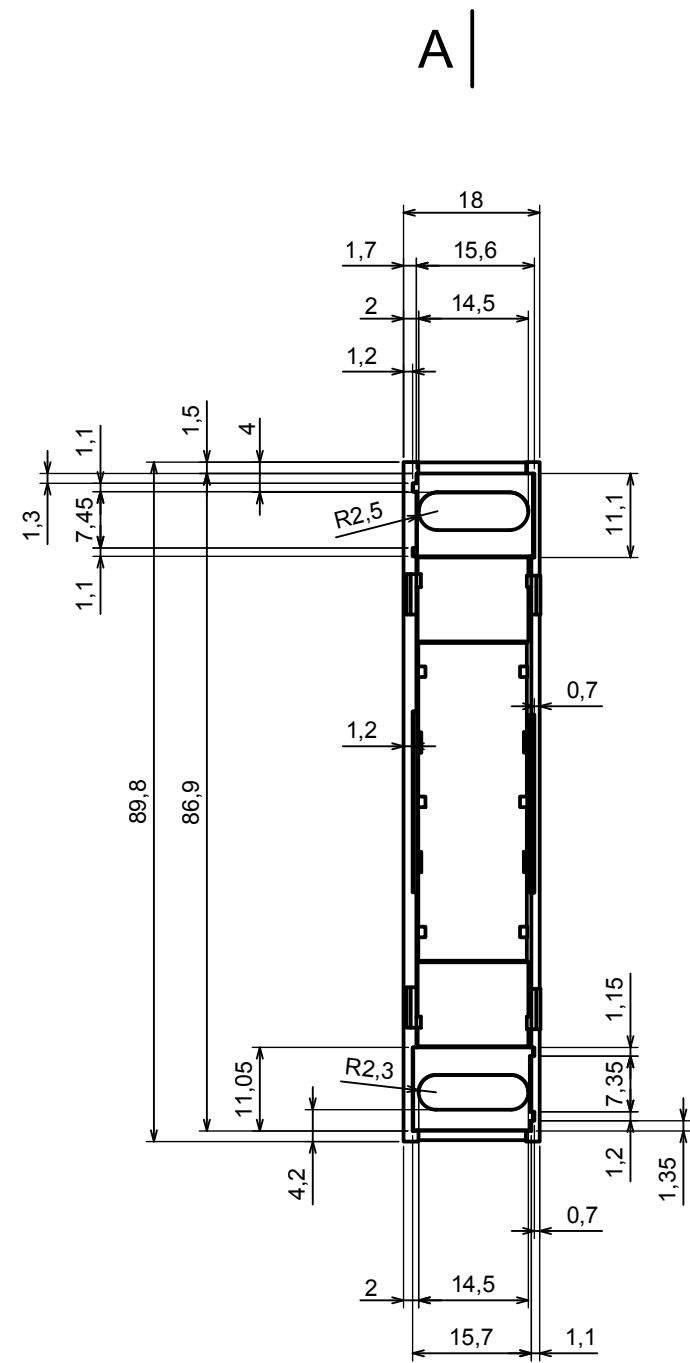

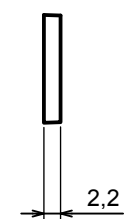
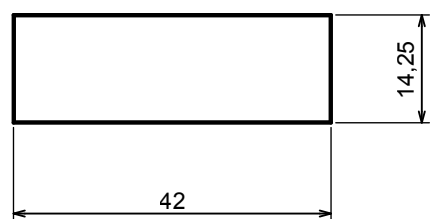

A |

All rights reserved, Copyright Kradox 2017		
Product model	Enclosure Z105 - Cover	
Format: A3	Material: PS, ABS	
Scale 1:1	Tolerance: +/- 0.8	

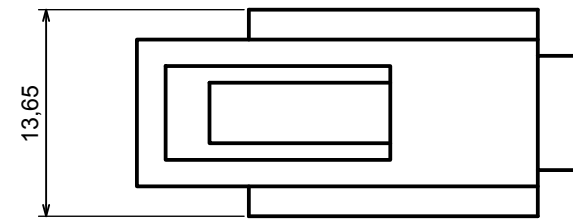
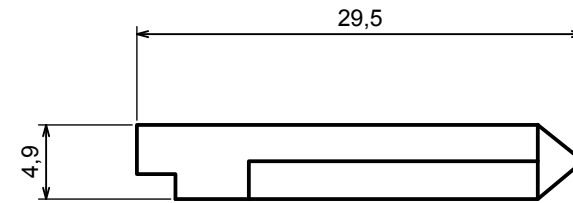

All rights reserved, Copyright Kradox 2017		
Product model	Enclosure Z105 - Filter	
Format: A3	Material: PS, ABS	
Scale 1:1	Tolerance: +/- 0.8	



All rights reserved, Copyright Kradex 2017		
Product model	Enclosure Z105 - Hook	
Format: A3	Material: PS, ABS	
Scale 2:1	Tolerance: +/- 0.5	